

047C3015

047C3015

Circuit breakers type CTI 15 20-25A and auxiliary contact type CBI

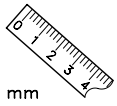
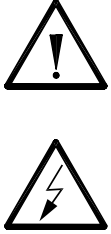

mm

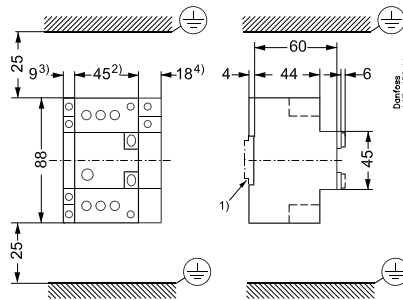

- 1) EN 50022
- 2) CTI 15
- 3) CBI - 11
- 4) CBI - UA / AA

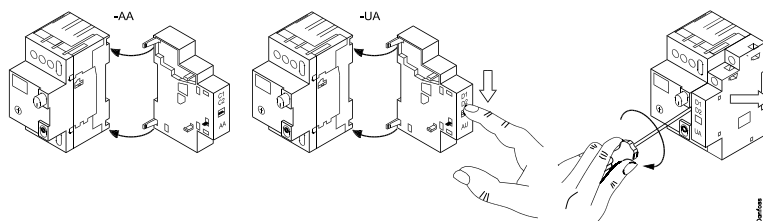
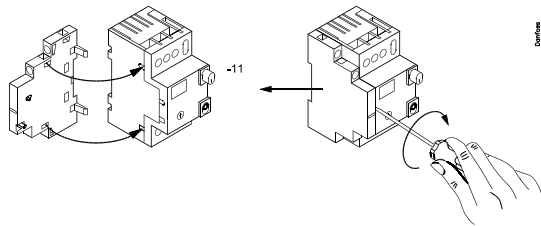
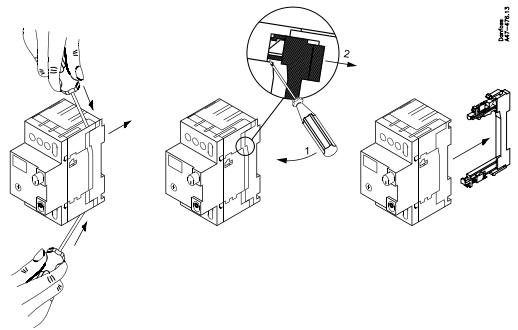
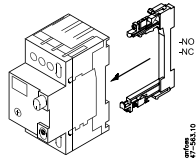
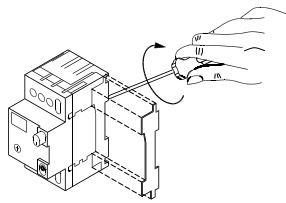

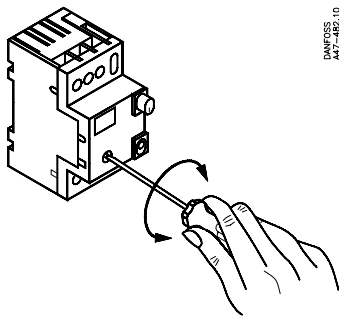
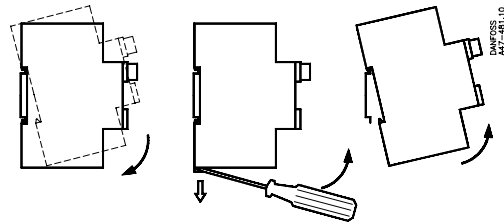
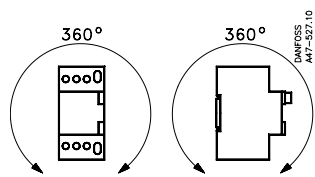
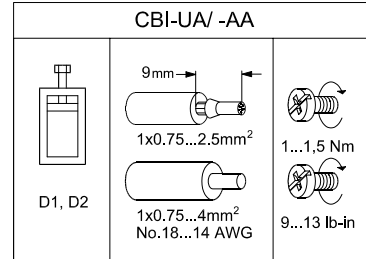
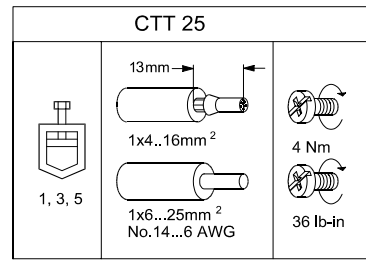
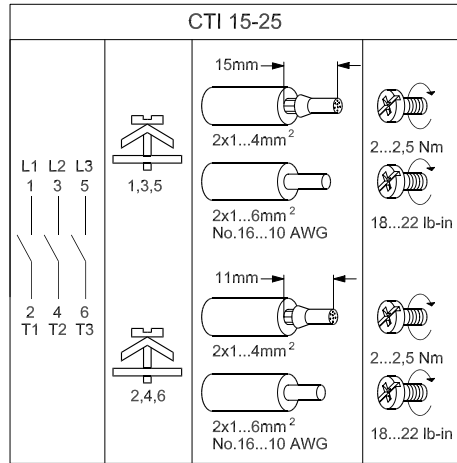

CTI 15		220-240V	400/415V	500V
		gG, aM	gG, aM	fG, aM
25	20-25A	80A	80A	80A

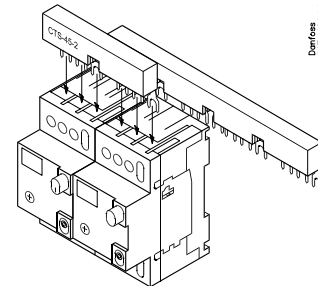
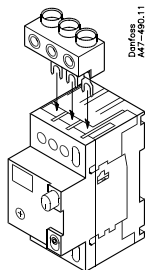

Warning
Opening of branch circuit protective device may indicate that a fault current has been interrupted. To reduce the risk of fire or electric shock current carrying parts or other components of the controller should be examined and replaced if damaged. If burnout of the current elements occurs the complete overload relay must be replaced.